

# RhinoStop<sup>®</sup>

Car Park & Industrial Crash Barriers



**SafeDirection**  
CRASH BARRIER SOLUTIONS

[safedirection.com.au](http://safedirection.com.au)



# The RhinoStop® Advantage

## Leading Safety

Full scale crash tested systems on edge of suspended thin slabs

Compliance to AS/NZS 2890.1 Parking Facilities

Compliance to AS/NZS 1170.1 Structural Design Actions

BCA compliant solutions

## Energy Absorbing

Patented yielding base plate design

Controlled absorption of vehicle impact energy

Lower anchor bolt forces

Prevents damage to concrete substrate

## Architectural Solutions

Aesthetic design options

High cross ventilation

## Fast Assembly

Fully modular systems

Fewer anchor bolts per post

## Durable

Galvanised components

## Local Support

Designed by Safe Direction for Australian and New Zealand Standards

Customised solutions available for non-standard applications



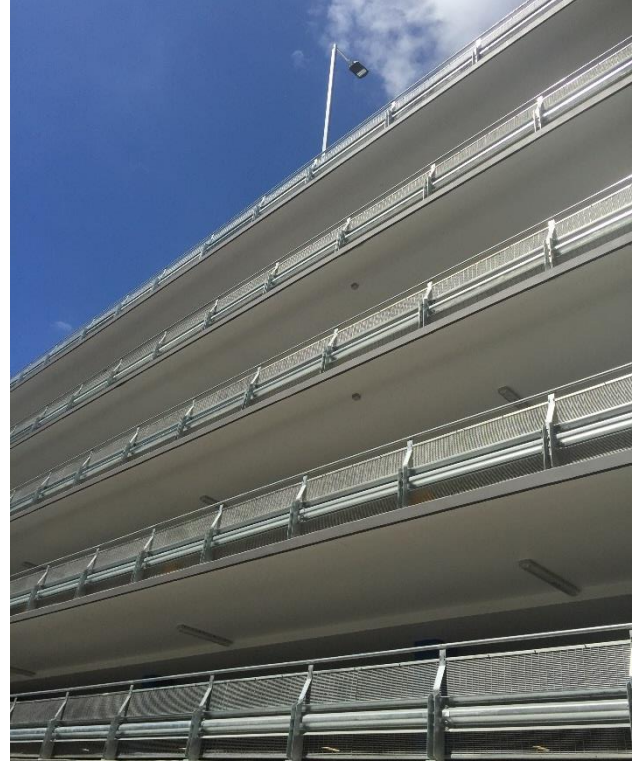





## 1.0 Introduction

Car park barriers are a specific range of safety barrier systems designed for the protection of people, buildings, plant and equipment. Their design and function are specific to vehicle movements encountered in a car park or warehouse/industrial environment.

Designers of car park and industrial barriers should consider the following:

- The barriers should be capable of withstanding impact loads in accordance with relevant Australian standards and building code;
- Impacts are likely to be perpendicular to the barrier i.e. 90 degrees;
- Pedestrian walkways or thoroughfares adjacent to the barrier;
- Channelling of people or restriction of access
- Falls or drops behind the barrier;
- Available space for a barrier system; and
- Impact damage should be confined to the barrier system and not the car park structure

## 2.0 How RhinoStop Works

RhinoStop posts are significantly stronger than a similarly sized and anchored rigid post. The vulnerability of rigid posts is the high peak load transferred to the anchors upon vehicle impact typically resulting in anchor failure.

All RhinoStop barriers incorporate a unique patented yielding base plate that minimises the peak loads transferred to post anchors.

The defining feature of RhinoStop posts are the long cuts in the base plate breaking the plate into three

fingers connected by a common stem. The fingers allow the mounting of the post upright to be separated from the anchor(s)

Upon impact from a vehicle, a plastic hinge will form at the location where the fingers that the post is mounted to begins to rotate backwards. This deformation serves two primary functions:

1. The load capacity of the plastic hinge is designed to be less than the pull-out capacity of the anchor bolt
2. The deflection of the system allows for greater load transfer to adjacent posts thereby sharing the impact load from the vehicle





### 3.0 Crash Test Validation

The various RhinoStop systems have been crash test validated at impact speeds and loads well in excess of those stipulated in AS/NZS 1170.1

Moreover, RhinoStop systems have been crash test validated with posts installed at: mid slab positions; on concrete footings; and on the edge of suspended thin concrete slabs – the later contemplates possible edge failure that cannot be validated via testing on a concrete footing or a barrier position away from the edge of slab.

Suspended slab tests were performed on 150mm thick slabs, 32MPa concrete using 187mm Fischer FBN-II galvanised mechanical anchors torqued to 200nm and with an embedment depth of 100mm.







## 4.0 Load Compliance (AS/NZS 1170.1)



AS/NZS 1170.1 load of 30kN acting at 0.5m above ground level  
Based on a 1,500 kg vehicle travelling at 2m/s or 7.2km/h  
**Impact Energy 3.0 kJ**



Crash tested to contain 1,500kg vehicle at 15km/h at 0.5m  
**Impact Energy 13.0 kJ**  
Minimum 3 posts

### RhinoStop Standard



Crash tested to contain 1,500kg vehicle at 15km/h at 0.5m  
**Impact Energy 13.0 kJ**  
Minimum 3 posts

### RhinoStop SkyEdge



Crash tested to contain 1,500kg vehicle at 15km/h at 0.5m  
**Impact Energy 13.0 kJ**  
Minimum 3 posts

### RhinoStop Screen



AS/NZS 1170.1 load of 40kN acting at 1.0m above ground level  
Based on a 2,000 kg vehicle travelling at 2m/s or 7.2 km/h  
**Impact Energy 4.0 kJ**



Crash tested to contain 2,000kg vehicle at 20km/h at 1.0m  
**Impact Energy 31.0 kJ**  
Minimum 3 posts

### RhinoStop Elite



Crash tested to contain 2,500kg vehicle at 20km/h at 1.0m  
**Impact Energy 37.0 kJ**  
Minimum 5 posts

### RhinoStop TruckGuard



AS/NZS 1170.1 load of 240kN acting at 0.5m above ground level  
Based on a 1,500 kg vehicle travelling at 6m/s or 21.6 km/h  
**Impact Energy 27.0 kJ**



Crash tested to contain 1,500kg vehicle at 29km/h at 0.5m  
**Impact Energy 64.0 kJ**  
Minimum 6 posts

### RhinoStop 240

## 5.0 Height Compliance

The Building code of Australia requires that a 1m high continuous balustrade be provided along the side of a floor if the trafficable surface is 1m or more above the surface beneath.

AS/NZS 2890.1 If reverse parking is to be permitted then barrier at the end of a car parking space shall be at least 1.3m high so that drivers backing into the space can see the barrier above the rear of the vehicle



## 6.0 Anti-Climb Requirements

The Building Code of Australia stipulates that if the drop to the lower level exceeds 1m, openings in the barrier must not allow a 125mm sphere to pass through; and

If the drop to a lower level exceeds 4 metres, any horizontal elements between 150mm and 760mm above the floor must not facilitate climbing

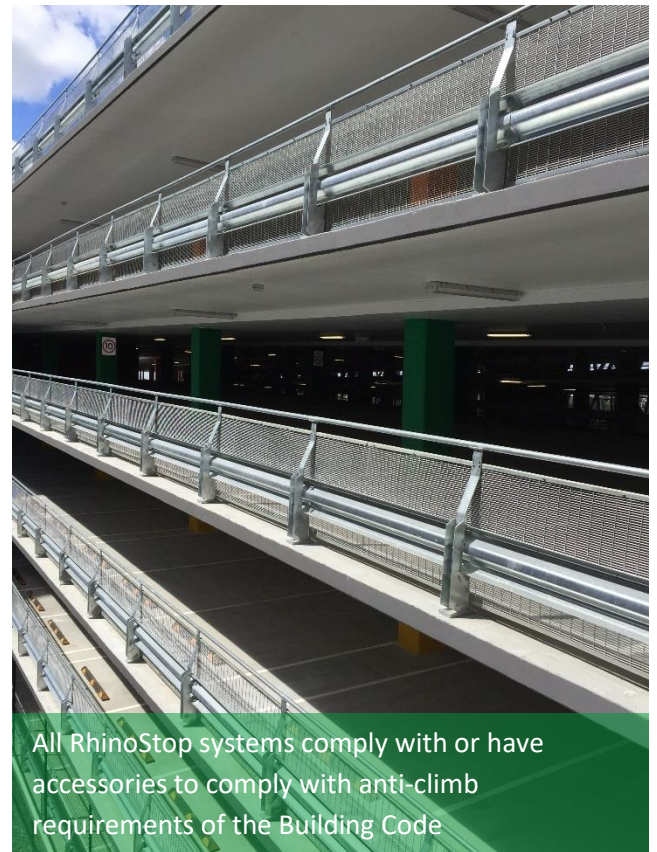





## 7.0 RhinoStop (Standard)

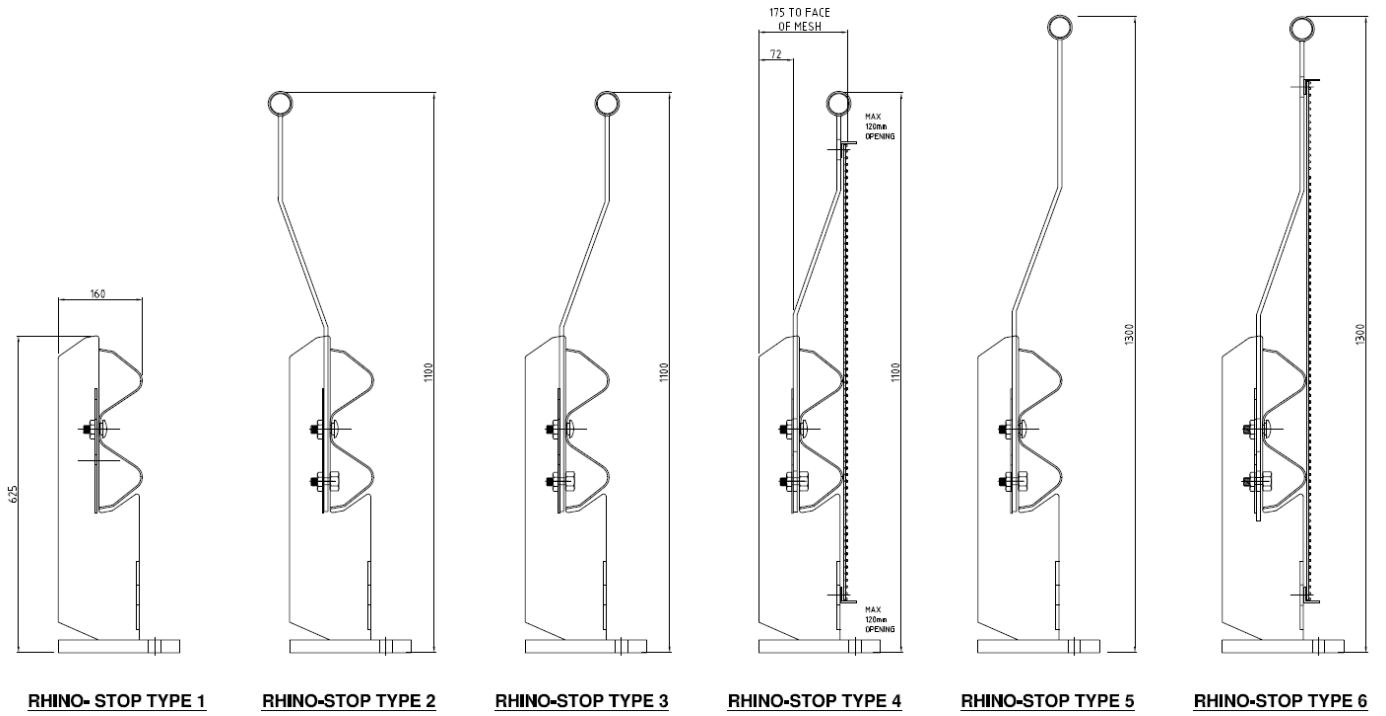

RhinoStop Type 1



RhinoStop Type 2



RhinoStop Type 3



RhinoStop Type 4



RhinoStop Type 5

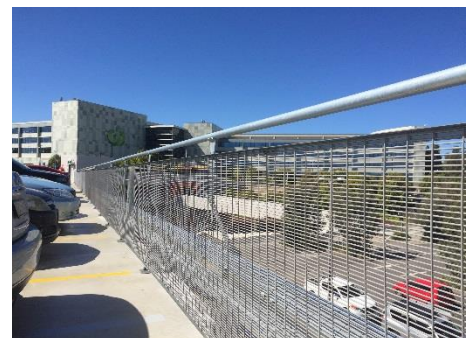

RhinoStop Type 6





## 8.0 RhinoStop SkyEdge

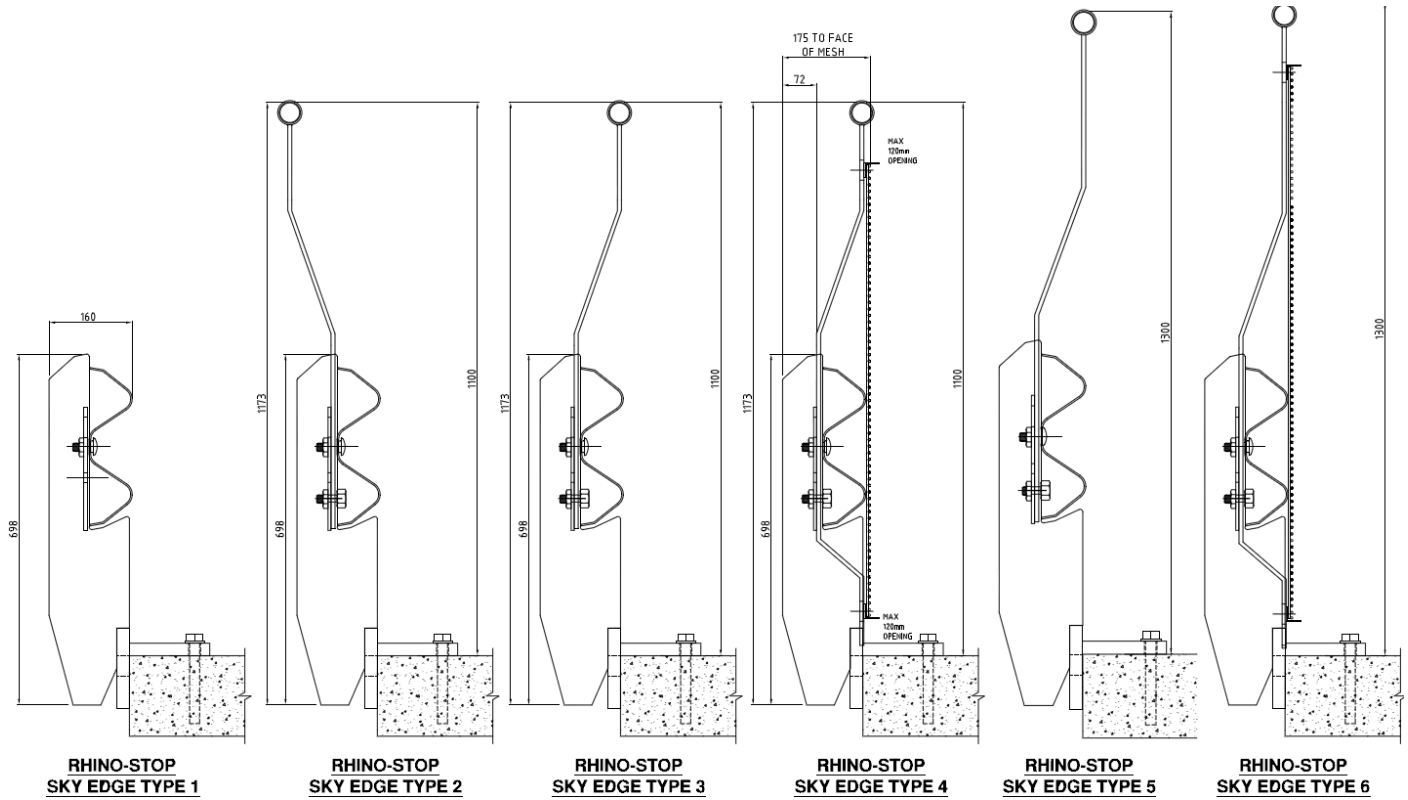



## 9.0 RhinoStop 240

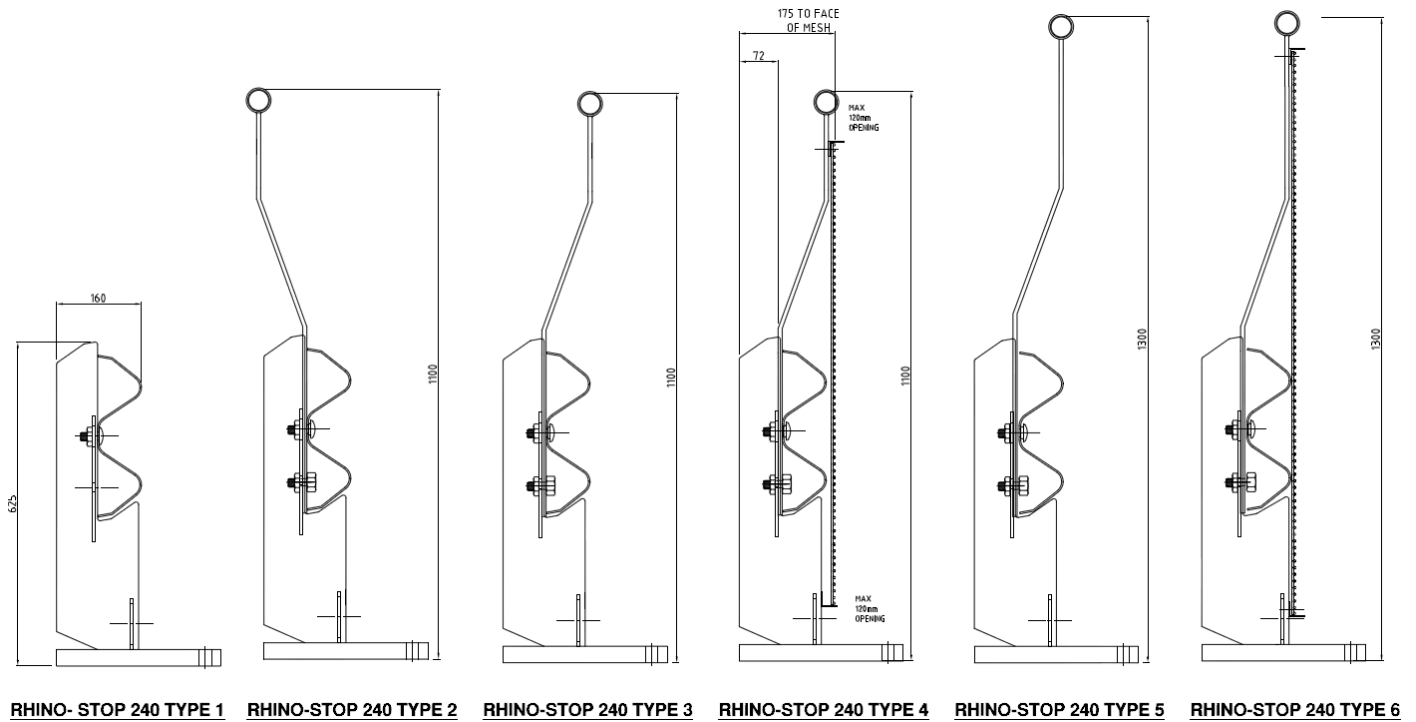





**10.0 RhinoStop Screen**

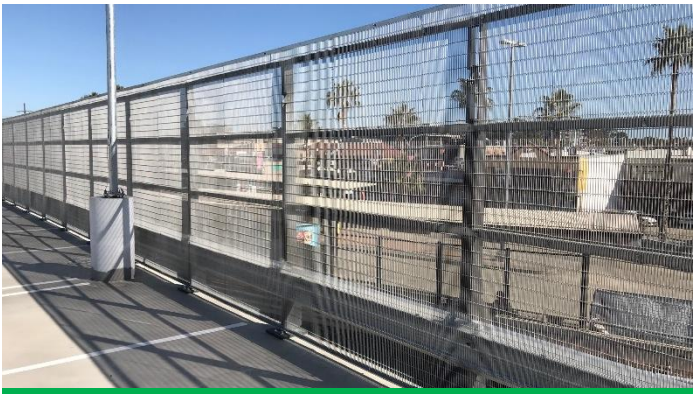
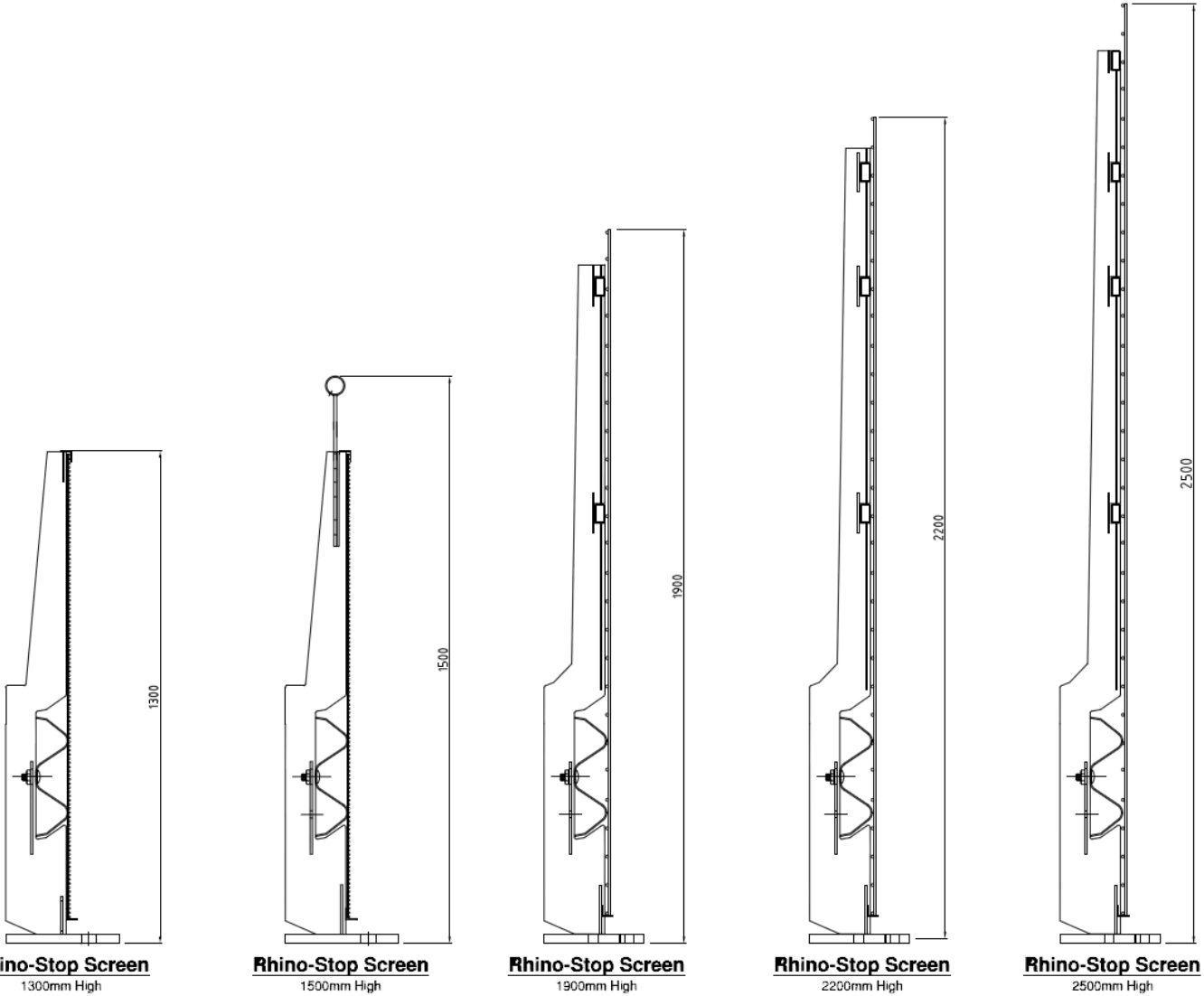

RhinoStop Screen 2500mm high system



RhinoStop Screen 2500mm high system



## 11.0 RhinoStop Elite

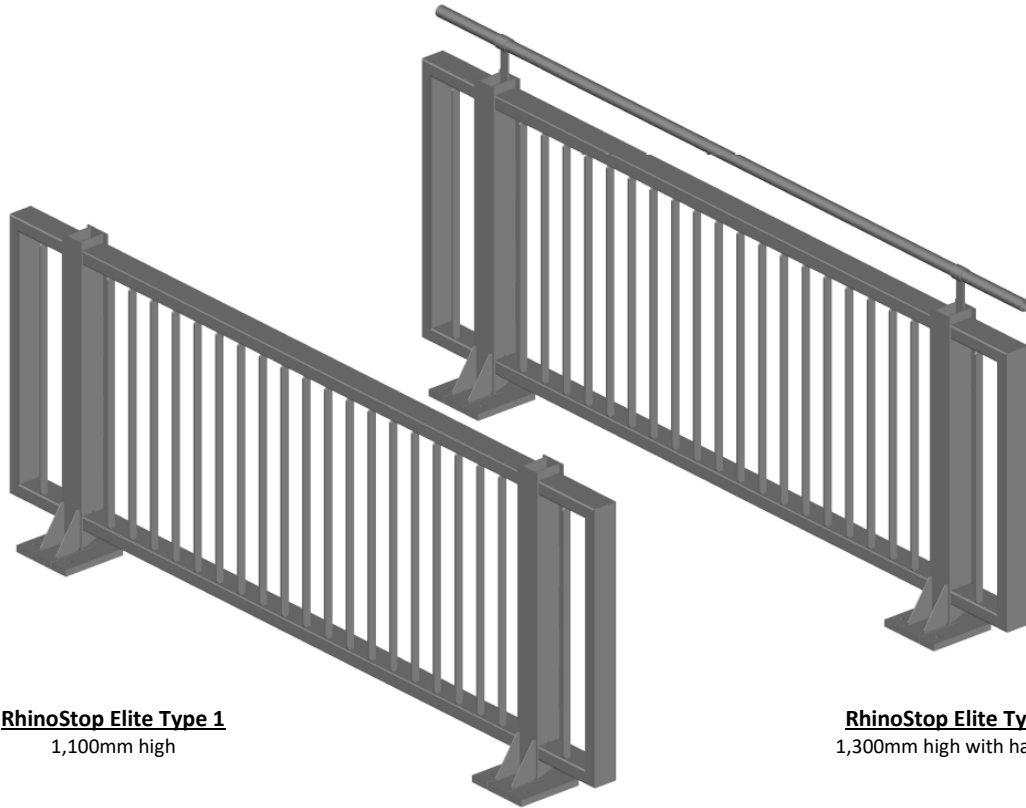

**RhinoStop Elite Type 1**  
1,100mm high

**RhinoStop Elite Type 2**  
1,300mm high with handrail



RhinoStop Elite: split level basement



RhinoStop Elite: perimeter edge



RhinoStop Elite: industrial application

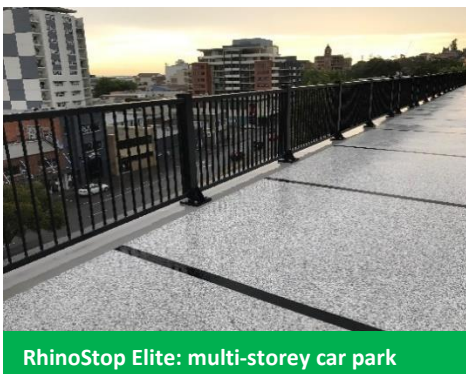

RhinoStop Elite: multi-storey car park

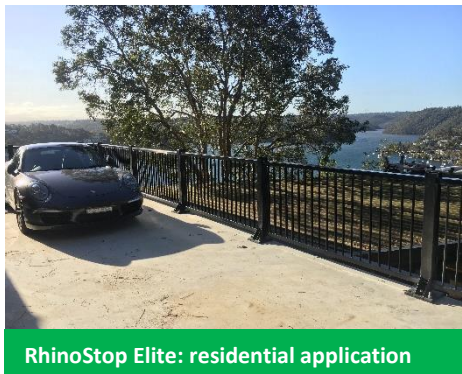

RhinoStop Elite: residential application

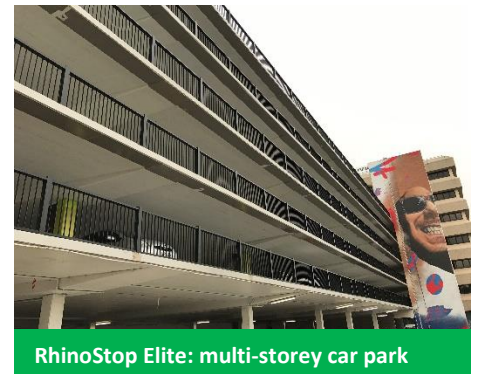

RhinoStop Elite: multi-storey car park





## 12.0 RhinoStop TruckGuard

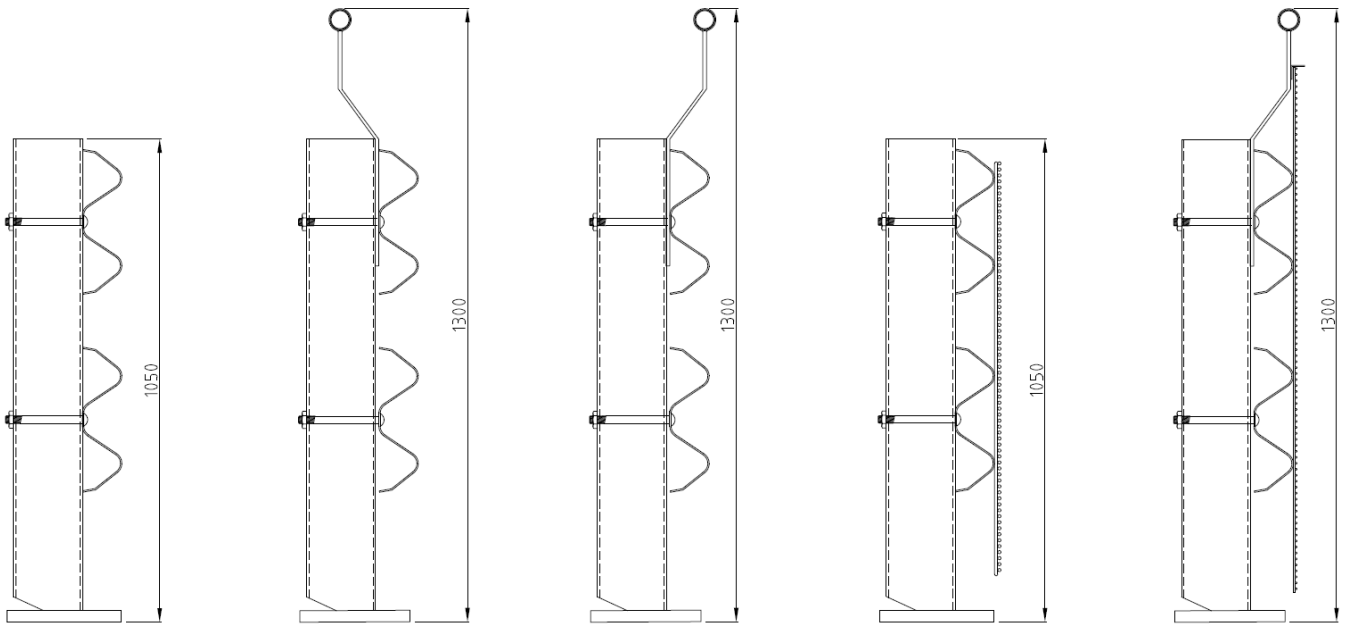

**Rhino-Stop Truck Guard**  
**Type 1**  
Guardrail

**Rhino-Stop Truck Guard**  
**Type 2**  
Guardrail &  
Offside Balustrade

**Rhino-Stop Truck Guard**  
**Type 3**  
Guardrail &  
Nearside Balustrade

**Rhino-Stop Truck Guard**  
**Type 4**  
Guardrail  
Anti-Climb Mesh

**Rhino-Stop Truck Guard**  
**Type 5**  
Guardrail, Balustrade &  
Anti-Climb Mesh

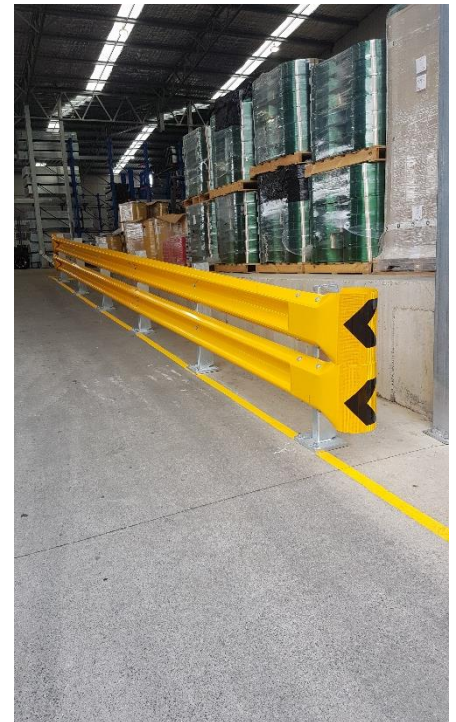



## 13.0 Installation

### 13.1 Turn Key (Supply, Install and Certification)

Safe Direction can supply only or offer the complete turn key solution of supply, install and certification for compliance to AS1170.1 for car park barriers.

### 13.2 Tools Required

Standard tool requirements for any of the RhinoStop systems are:

- Air compressor
- Impact drill with 20mm masonry bit
- Rattle gun with 24mm and 32mm socket and or
- Ratchet wrench with 24mm and 32mm socket
- Torque wrench (capacity up to 200Nm)
- Drop Saw
- Driver, small socket set and step drill bit
- Grinder with metal cutting disk
- Copper headed hammer
- 12mm Pinch bar
- Metal snips
- String line
- Tape measure
- Slings or chains
- Fall protection equipment (where required)

### 13.3 Recommended PPE

It is recommended that the following Personal Protective Equipment be provided and used as determined by risk assessment and or safe work instructions for nominated tasks

- Safety footwear
- Gloves
- Hearing protection
- High visibility clothing
- Fall protection equipment (where required)

### 13.4 Site Establishment

Prior to commencement of any work, the site should be evaluated for risk to workers, pedestrians and or other persons on site. The site should be assessed for any requirement for traffic control to manage safe travel for passing vehicles and or pedestrians and to protect workers.

#### Overhead Obstructions

The site should be evaluated for overhead obstructions that may present a risk during the installation process. These obstructions typically include power, signage, lighting and building structure.

#### Unloading

If you plan to unload on an elevated concrete deck you should first check that your vehicle does not exceed any mass limitations as well as check that the collective mass and footprint area of the product that you intend to unload does not exceed any mass limitations of the concrete deck.

Only appropriate load rated slings or chains should be used for the safe unloading of product. The mass of any lift should be verified before lifting – if in any doubt contact Safe Direction.

It is recommended that an exclusion zone be maintained around the unloading process. This provides distance between moving machinery, product and workers.

Unloading and the storing of product on a level surface is recommended. Storing product adjacent to the installation area eliminates the requirement for workers to carry items over long distances.



### 13.5 Footing/Substrate

#### Concrete Curing

If installing RhinoStop barriers onto a recently poured concrete substrate, the concrete must be fully cured prior to the installation of anchor bolts. Curing time can vary from site to site and is to be advised by the site construction manager.

#### Concrete Substrate Thickness

RhinoStop barriers have been tested on concrete substrates of just 150mm thickness (32MPa) with the rear of post positioned at the edge of slab.

Contact Safe Direction for advice on suitability of installation of RhinoStop on thinner slabs.

#### Concrete Encased Services

The installation of RhinoStop requires the drilling of holes into a concrete substrate. Prior to drilling, investigation for potential hazards such as post tension tendons, heavy reinforcement, service conduits, electrical conduits etc is recommended. These items should be identified and marked before set-out.

### 13.6 Assembly

#### Set-Out

It is recommended that a string line be used to establish alignment of the post locations. When establishing the post locations, take care to note the following:

- Location of any identified post tensioning cables, heavy rebar and any service conduits in the concrete substrate
- Maximum post spacing for the product is listed in Table 1
- Minimum number of posts for short installations is listed in Table 1

- The back of the post must not extend beyond the edge of the concrete slab (RhinoStop Sky Edge excepted)
- Sufficient clearance behind the post to a fixed hazard is required to allow for deflection of the system (speak with Safe Direction about your application)

#### Anchors

All RhinoStop systems utilise the same anchor specification with the only variance being the number of bolts per post. See Table 1 for the number of anchors per post for the different RhinoStop systems.

RhinoStop systems have been crash test validated using Fischer FBNII M20 galvanised mechanical anchors.

Minimum required embedment depth is 100mm.  
Minimum required bolt torque is 200Nm.

Alternate fixing methods including chemical anchors may be available depending on the application. Please contact Safe Direction for details.

The Fisher FBNII M20 mechanical anchor is a pre-assembled single unit designed for solid concrete applications. Fixing is achieved by controlled torqueing of the nut which draws a tapered section up into the clip, thereby expanding it outward and forcing it against the sidewall of the pre-drilled hole. Application is achieved via the following method:

1. Using a 20mm drill bit size (must be the same size as the mechanical anchor), drill the hole to a minimum depth of 105mm
2. Blow the dust from the hole using a blowout pump or compressed air ensuring that the hole is free from loose materials
3. Position the nut close to the tip to protect the thread from accidental damage during installation. Drive the bolt into the hole by hammering with a copper or other soft headed hammer
4. Position the post and apply a torque of 200Nm to the nut of the anchor fixing

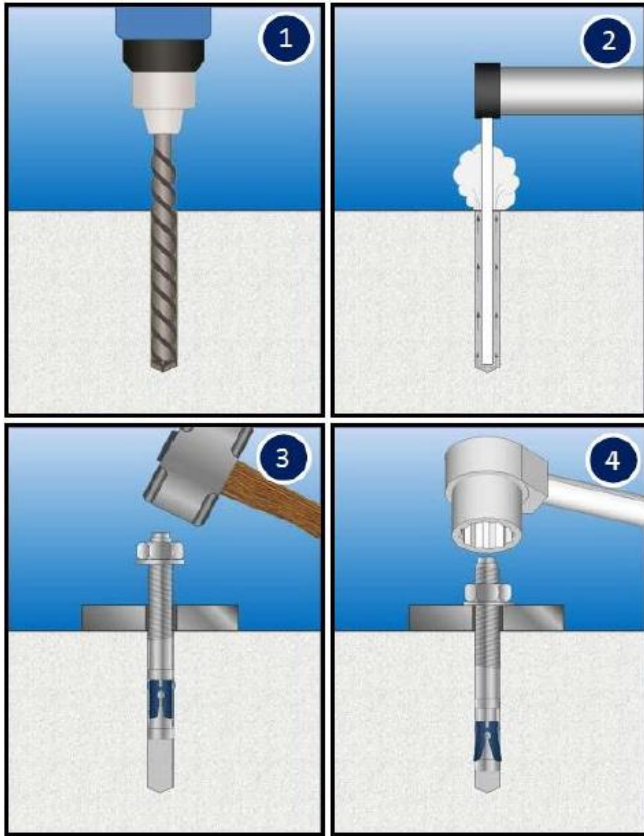

### Cutting and Drilling

During the assembly sequence it may be necessary to cut and drill standard length items to suit site dimensions.

Cutting of w-beam guardrails, pipe angles and mesh is undertaken using a metal cutting disk.

Drilling of new holes can be undertaken using a step drill bit.

Any damage to the galvanised coating should be reinstated with 2 coats of an organic zinc rich paint and finished with a silver gal top coat for aesthetics.

Oxy acetylene equipment is NOT to be used to cut the w-beam rails, mesh, pipe and support angles.

Table 1: Post set out details

System	Anchors per Post	Maximum post spacing (metres)	Minimum posts per installation for compliance to AS/NZS 1170.1	
			Type F Compliant	Type G Compliant
RhinoStop (Standard)	1	2.0	3	NA
RhinoStop SkyEdge	1	2.0	3	NA
RhinoStop Screen (up to 1500mm)	2	2.0	2	NA
RhinoStop Screen ( $\geq$ 1500mm)	3	2.0	2	NA
RhinoStop Elite	2	2.3	2	3
RhinoStop TruckGuard	2	2.0	2	3
RhinoStop 240*	2	0.8	6	NA

Note: \*RhinoStop 240 compliance is to the 240kN load criteria for barrier applications opposite a down ramp longer than 20 lineal metres. The remaining Type E compliance levels are for the 30kN load requirement.



### Assembly Sequence

1. Install the Fisher FBNII M20 Anchors and secure the posts as described above
2. The W-beam guardrails are secured to the posts using a M16 x 50mm mushroom head bolt and oversized nut (M16 x 180mm for RhinoStop Truck Guard). The nut is tightened using a hand socket and a 32mm attachment.
3. The W-beam guardrails are spliced together using 8 off M16 x 32mm mushroom head bolts and oversized nuts. The lap orientation of the rail should be consistent throughout the installation. Speed of installation is assisted by using a pneumatic driver with 32mm attachment. The use of a pinch bar will assist in aligning the splice holes as the bolts are inserted. The use of a driving pin to elongate the splice holes is not permitted. The splice bolt and nut assembly should be torqued to a snug fitting.
4. The remainder of the installation should be assembled as per the assembly drawings for the various types of barrier – see Installation Checklists and Assembly Drawings for details

### Installation Checklists and Assembly Drawings

Checklists and assembly drawings are available for all RhinoStop systems and should be followed and used for the purpose of ensuring and auditing a compliant installation.

Check lists and assembly drawings are available from Safe Direction or from the Safe Direction website:

[www.safedirection.com.au](http://www.safedirection.com.au)

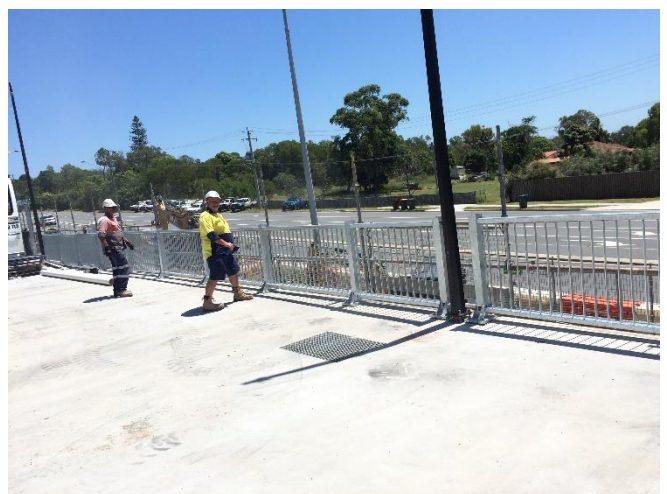





## 14.0 Example Sector Projects

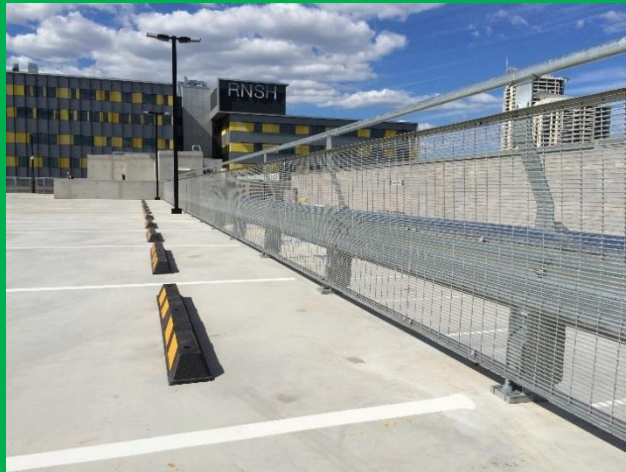

Royal North Shore Hospital



Wollongong Hospital

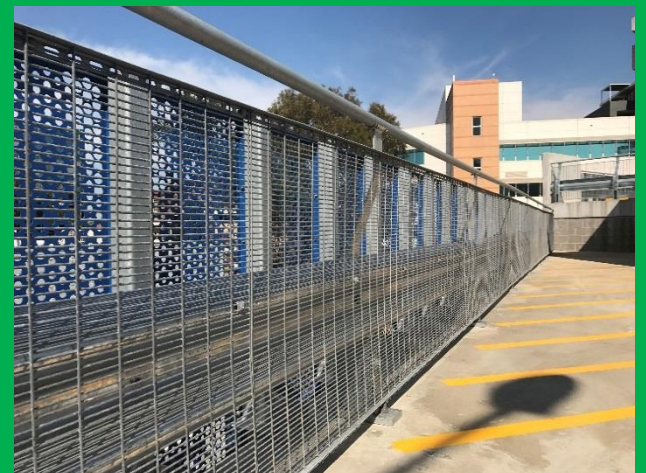

Lismore Hospital

St George Private Hospital

Health





**Padstow Commuter Car Park**



**Canley Vale Commuter Car Park**



**Penrith Commuter Car Park**



**Holsworthy Commuter Car Park**

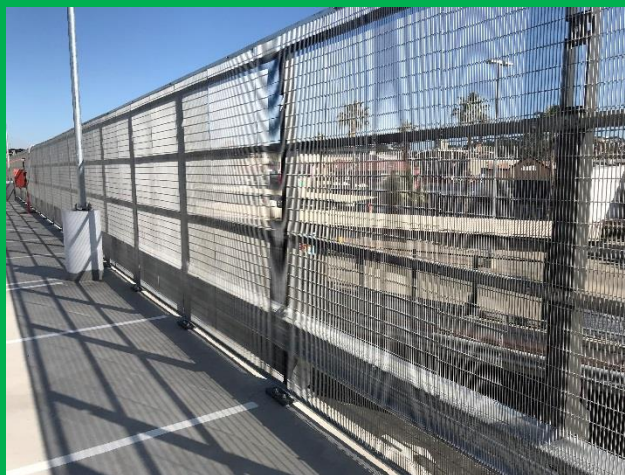

**Marylands Commuter Car Park**



**Holsworthy Commuter Car Park**

Transport





Super Yacht Marina



Newcastle Civic Car Park



Canterbury Hurlestone Park RSL



Wollongong Council Car Park Upgrade



Royal Randwick Racecourse



Super Yacht Marina

Community



Commercial



Coles Head Office Taroonga



Woolworths Head Office NorWest Business Park



Travelodge Sydney Airport



Endeavour Energy Field Service Centre



Connect Corporate Centre



Norwest Business Park





Tamworth Retail Centre



Big Top Shopping Centre



Bunnings Eastern Creek



Tamworth Mercedes Benz



Sydney Markets



Ipswich Retail Centre

Retail





Caringbah Industrial Centre



Toll Eastern Creek



Freedom Foods Ingleburn



Interchange Drive Eastern Creek

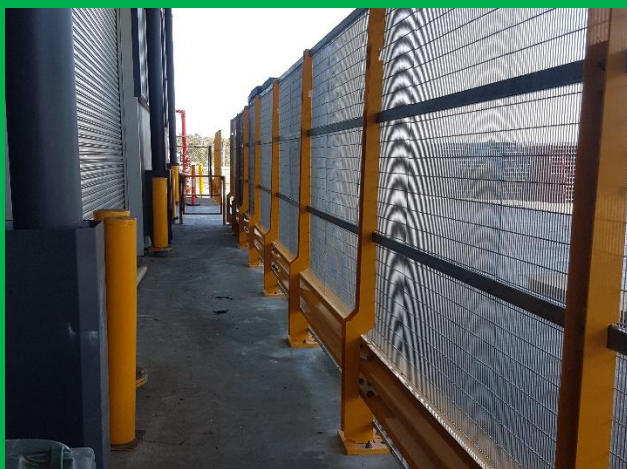

Allied Pinnacle

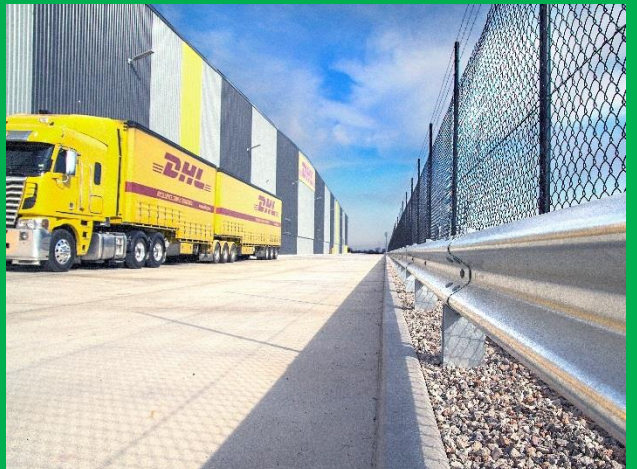

DHL Horsley Park

Industrial



[Safedirection.com.au](http://Safedirection.com.au)